

B43x5

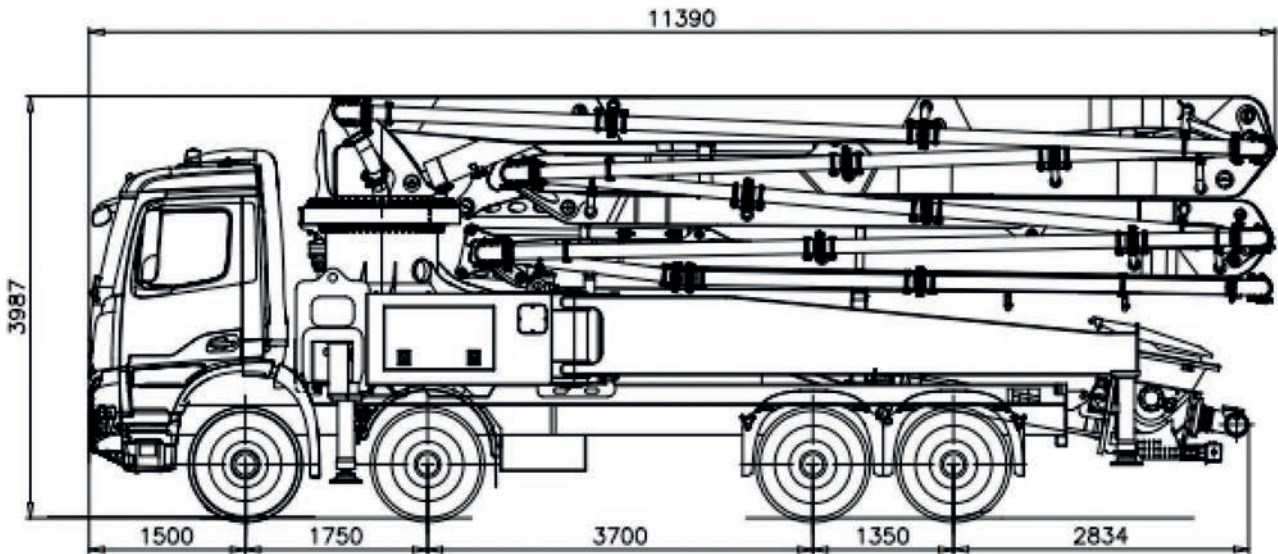

dimensions are informative and depend on the truck composition chosen

PUMPING UNIT XJG5320	
max. concrete flow rate*	160 m ³ /h
max. concrete pressure*	80 bar
max. number of strokes	29/min
stroke length	1800 mm
diameter of concrete cylinder	260 mm
hopper capacity	700 l

*the data given are theoretical values and cannot be reached simultaneously.

- powered by PTO transmission of the truck
- s-valve made of wear-resistant cast iron, equipped with a welded wear layer
- wear ring and wear plate with compensation system with inlay of tungsten carbide steel
- hydraulically driven and temperature controlled oil cooler
- mixing shaft with removable blades, fitted with a welded wear layer
- automatic grease lubrication system, hydraulically driven
- thick-walled 7" outlet bend with flushing hole
- concrete cylinder with hard chrome inner wall
- simply designed open hydraulic system
- electro-hydraulic controlled pumping unit
- separate control for pumping and s-valve cylinders supported with accumulator
- fuel-saving flow and speed control
- Rexroth hydraulic pumps with variable displacement
- aluminium cover with 2 led work lights



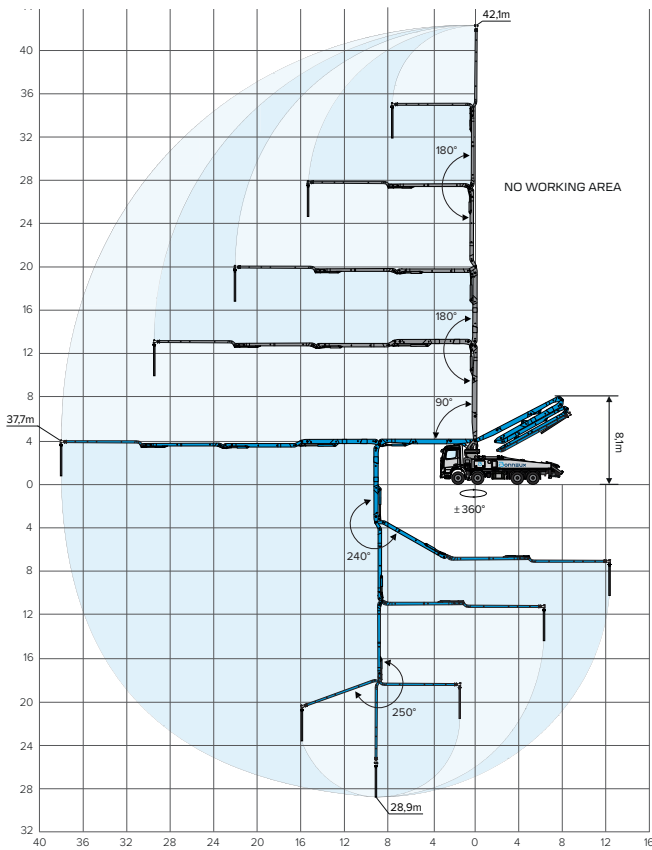

BOOM B43x5	
material	high-strength structural steel
strength calculation	FEM analyse
folding system	type 'z'
number of sections	5
max. vertical range	42,1 m
max. horizontal range	37,7 m
max. depth range	28,9 m
min. unfolding height	8,1 m
rotation angle	± 360°
turning angles	90°- 180°- 240°- 180°- 250°
control valve	proportional
max. hydraulic pressure	380 bar
pipeline	Ø 5" (DN 125)
end hose	Ø 5" (DN 125) - 3 m

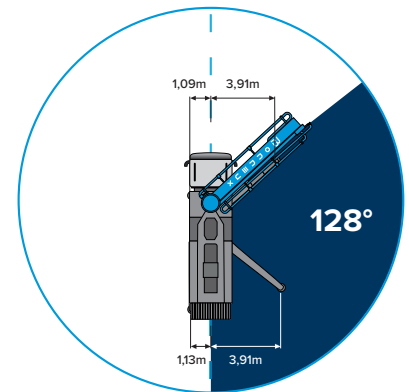
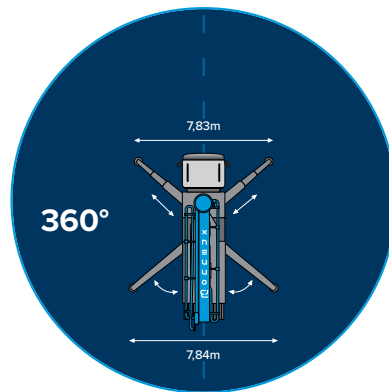
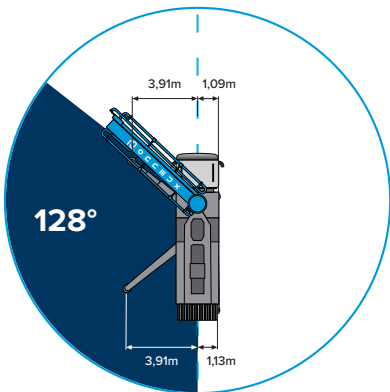

RADIO REMOTE CONTROL
2 TRANSMITTERS + 1 RECEIVER



HYDRAULIC CONTROL BOOM
PROPORTIONAL DIRECTIONAL
SPOOL VALVE

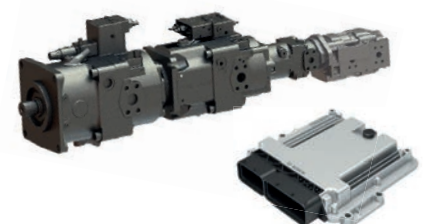

HYDRAULIC PUMPS
ELECTRONIC CONTROL UNIT
BODAS HARDWARE
CONTROLLER RC SERIES

our products are constantly evolving, which means specifications may vary